

LP VARI-FLEX®

UNITY
COMPATIBLE



The LP Vari-Flex is designed for users with long residual limbs that do not have enough clearance for the Vari-Flex.

Unity for LP Vari-Flex is a sleeveless vacuum suspension system designed to stabilize volume fluctuations and maintain comfortable socket fit throughout the day. For the moderately to high active user with limited build height clearance, Unity for LP Vari-Flex and Seal-In technology combined provide secure suspension, volume management and great foot dynamics without the restricting effect of an external suspension sleeve. Unity adds minimal weight to the prosthesis and does not interfere with the foot module dynamics.



ÖSSUR FEET

User Information	
Amputation Level:	Transfemoral and Transtibial
Impact Level:	Low to High
Maximum Patient Weight:	166kg (365lbs)



PROPORTIONAL
RESPONSE



CARBON-X®
ACTIVE HEEL



FULL LENGTH
TOE LEVER



SPLIT TOE

Foot Information	
Categories:	Size 22-24; Cat. 1-5 / Size 25-30; Cat. 1-9
Size:	22-30
Weight of Foot: (Size 27)	680g (24oz) w/ Pyramid and Foot Cover
Build Height: (Size 27)	68mm (2 11/16") w/ Pyramid and Foot Cover
Heel Height:	10mm (3/8")
Adapter Options:	Male Pyramid or Lamination Adapter

Unity System Information	
Maximum Vacuum:	-23inHg (-600mmHg)
Normal Operating Pressure:	-16-20 inHg
Added System Weight:	130g w/ Pump, Socket Valve and Tube

LP VARI-FLEX®

ORDERING INFORMATION

FOR COMPLETE FOOT WITH MALE PYRAMID

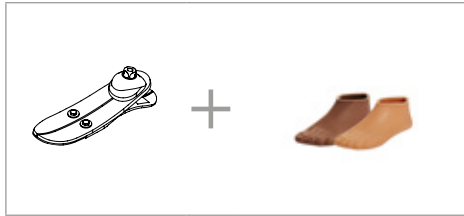

FOR COMPLETE FOOT WITHOUT ADAPTER



Unity can be ordered with LP Vari-Flex in the male pyramid, standard heel height configuration. Please select the appropriate Unity Pump Module kit according to foot module size when placing an order and Unity will come preassembled on the foot. For extra convenience and system compatibility, Unity Valve Kits are highly recommended as a means of connecting to the socket.

For liner selection charts and item numbers please refer to the appropriate Icross Seal-In page.

FOR COMPLETE FOOT WITH UNITY

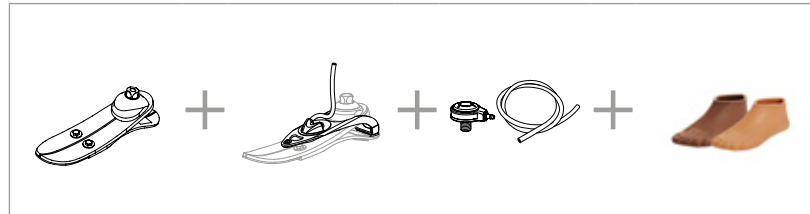

CATEGORY SELECTION CHART

Weight kg	45-52	53-59	60-68	69-77	78-88	89-100	101-116	117-130	131-147	148-166
Weight lbs	99-115	116-130	131-150	151-170	171-194	195-221	222-256	257-287	288-324	325-365
Low Impact Level	1	1	2	3	4	5	6	7	8	9
Moderate Impact Level	1	2	3	4	5	6	7	8	9	N/A
High Impact Level	2	3	4	5	6	7	8	9	N/A	N/A

CLEARANCE

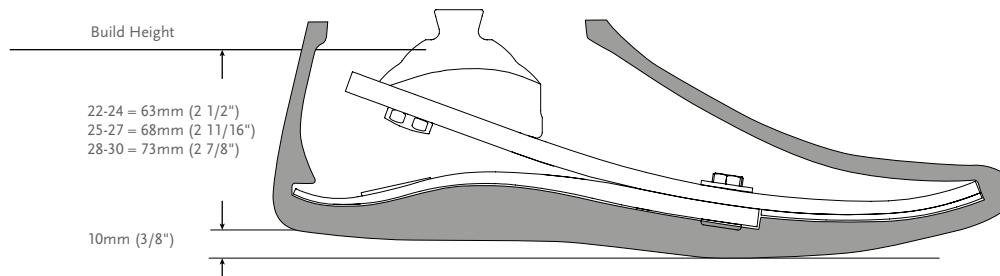

*Note: LP Vari-Flex with Unity has the same build height as LP Vari-Flex.

LP VARI-FLEX®

KITS

LP VARI-FLEX MALE PYRAMID OPTION

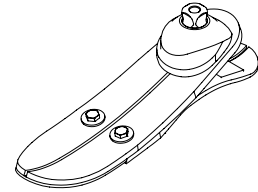
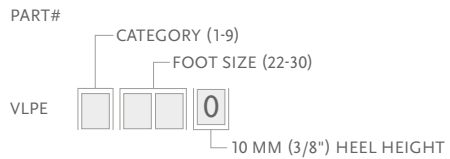

LP VARI-FLEX WITHOUT ADAPTER

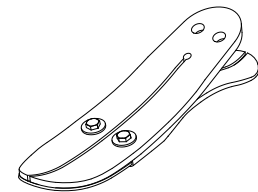
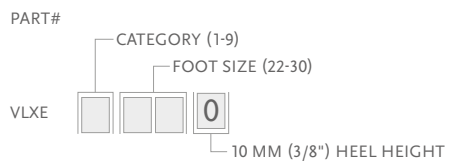

LAMINATION ADAPTER KITS

Part#	Cat.	Size
VLX00001	1-5	22-24
VLX00002	1-6	25-30
VLX00003	7-9	25-30

Includes:

- Lamination adapter
- Bolts
- Tape sealant
- Loctite

COMPONENTS

HEEL WEDGE KIT

For adjustment of heel stiffness and roll-over characteristics.

Part#	Foot Size
CM150011	22-30

Includes:

- 3 Wedges
- Adhesive



HEEL DIVIDER

Heel dividers act to separate the edges of a split heel to reduce wear and noise between the composite elements.

Part#	Description
CM140003	Heel Divider

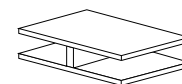

LOCTITE 410 BLACK

Part#	Description
CM160016	Loctite 410 black

LP VARI-FLEX®

UNITY

UNITY KITS

Picture	Part#	Description	Applicable Foot Kits
1	UVL0024	Unity Pump Module VLX 22-24	LP Vari-Flex Std Size 22-24
1	UVL0027	Unity Pump Module VLX 25-27	LP Vari-Flex Std Size 25-27
1	UVL0030	Unity Pump Module VLX 28-30	LP Vari-Flex Std Size 28-30
2	UTT0001	Unity TT Valve Kit	All
3	UTF0001	Unity TF Valve Kit	All
4	UTF0006	Unity TF Tube Kit	All

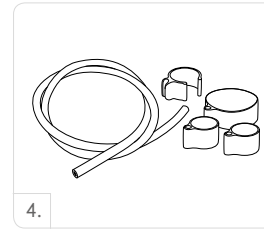
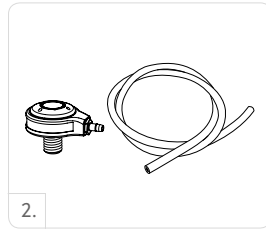
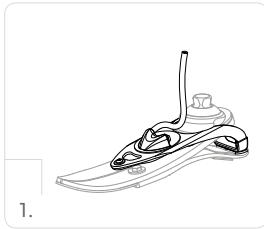

UNITY SPARE COMPONENTS

Part#	Description
UVL00021	Unity VL Components, 22-24
UVL00022	Unity VL Components, 25-30

Includes:

- Membrane
- Tube
- Check valves
- Tube fastener
- Barb fittings
- Heel pad

FOOT KITS APPLICABLE WITH UNITY

LP VARI-FLEX WITH MALE PYRAMID OPTION

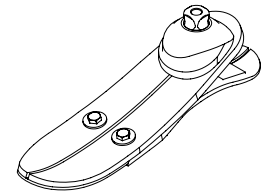
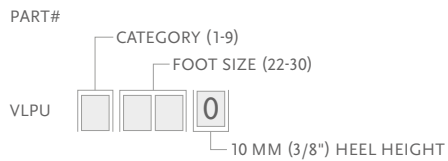

LP VARI-FLEX®

COSMETIC FINISHING

FOOT COVER KIT, BEIGE AND BROWN*

PART#

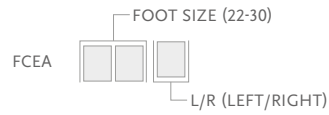

Includes:

- Foot Cover
- Flex-Foot Sock
- Foot Cover Attachment

*Please specify when ordering brown covers, add "BR" to the end of the part number.

FLEX-FOOT SOCKS

Used to cover the composite foot module to protect the foot and eliminate noise between foot module and foot shell.

Part#	Size
FCE63006	22-25
FCE63007	26-30



LP VARI-FLEX®

DIAGRAM

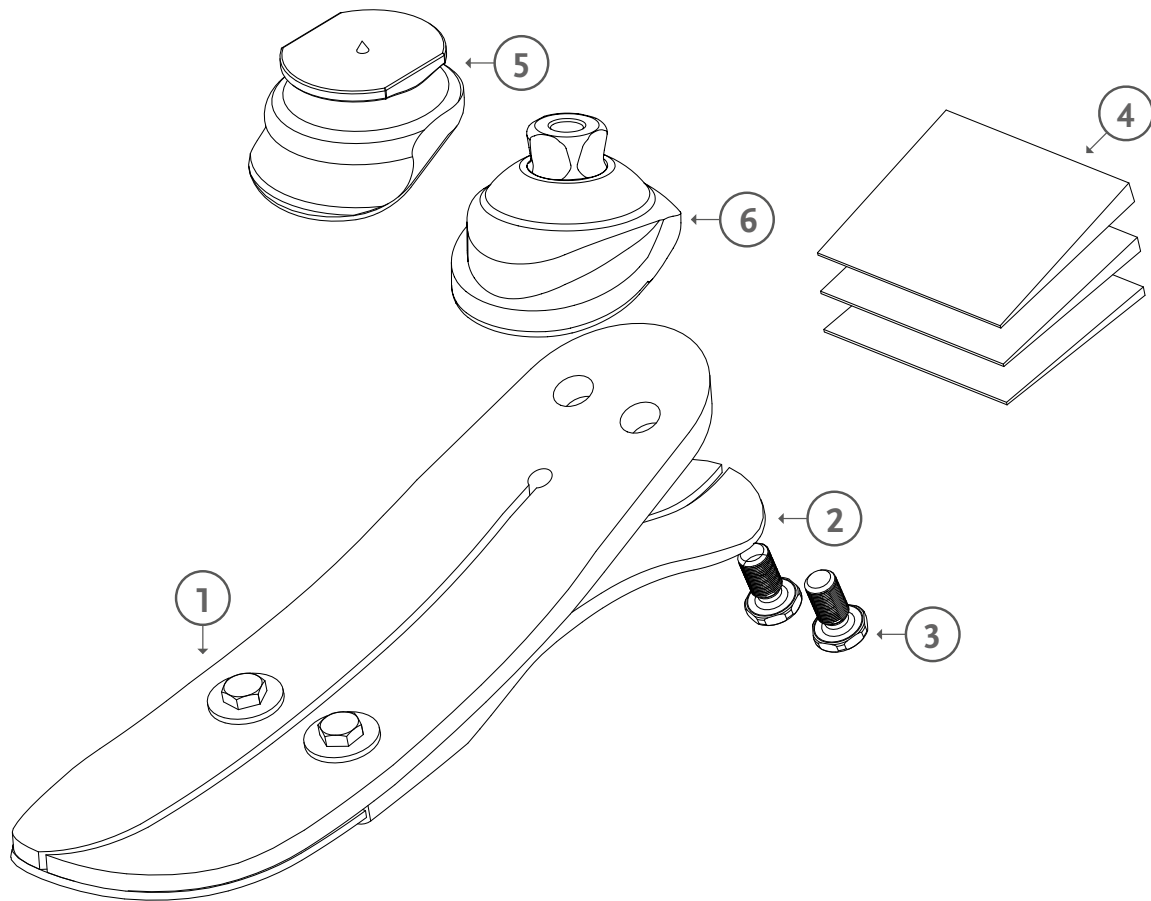

	Description
1.	Foot Module
2.	Heel
3.	Bolts
4.	Heel Wedge
5.	Lamination Adapter
6.	Male Pyramid Adapter